

FERTIGUNGS
BILDER

VIRGINIA
TUDOR

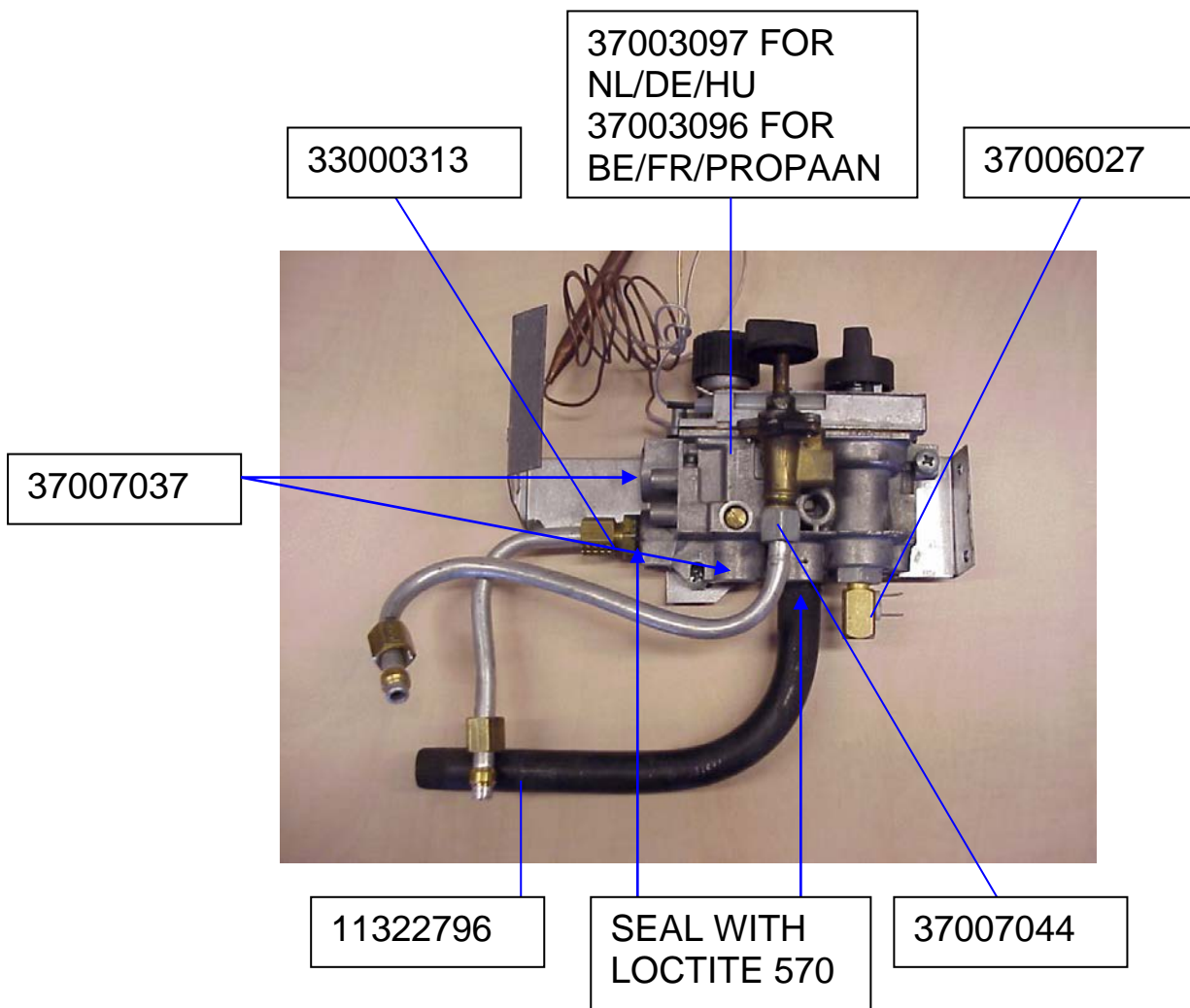

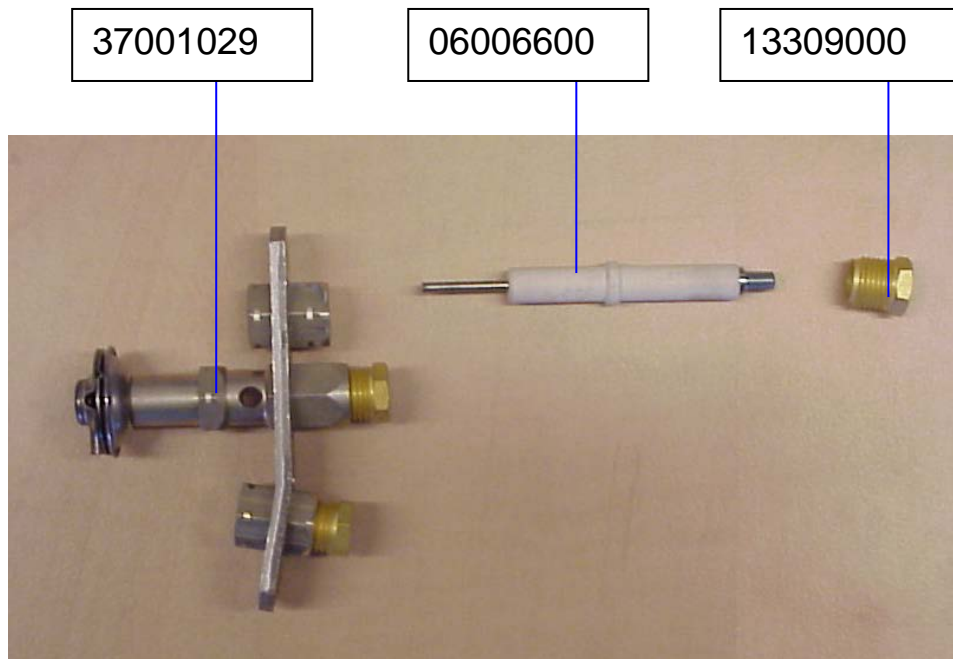

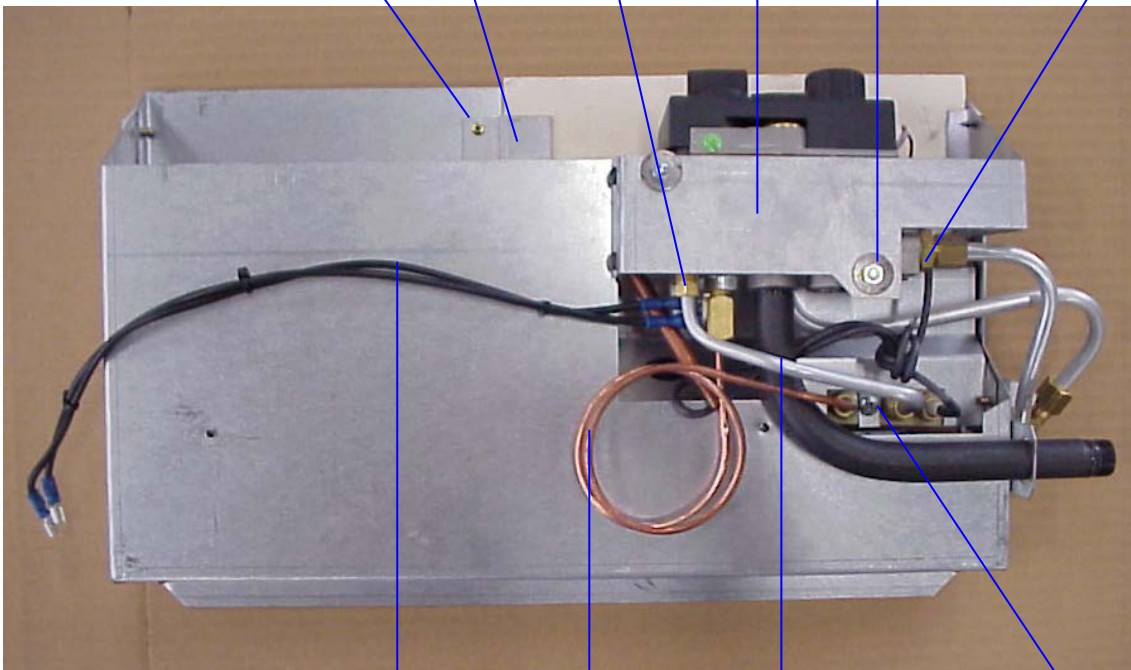
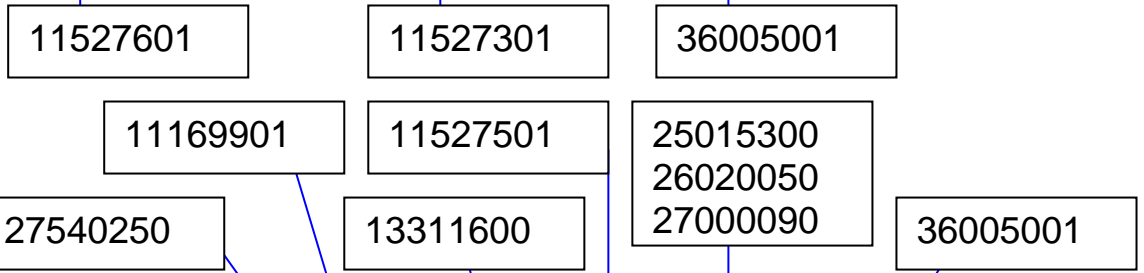
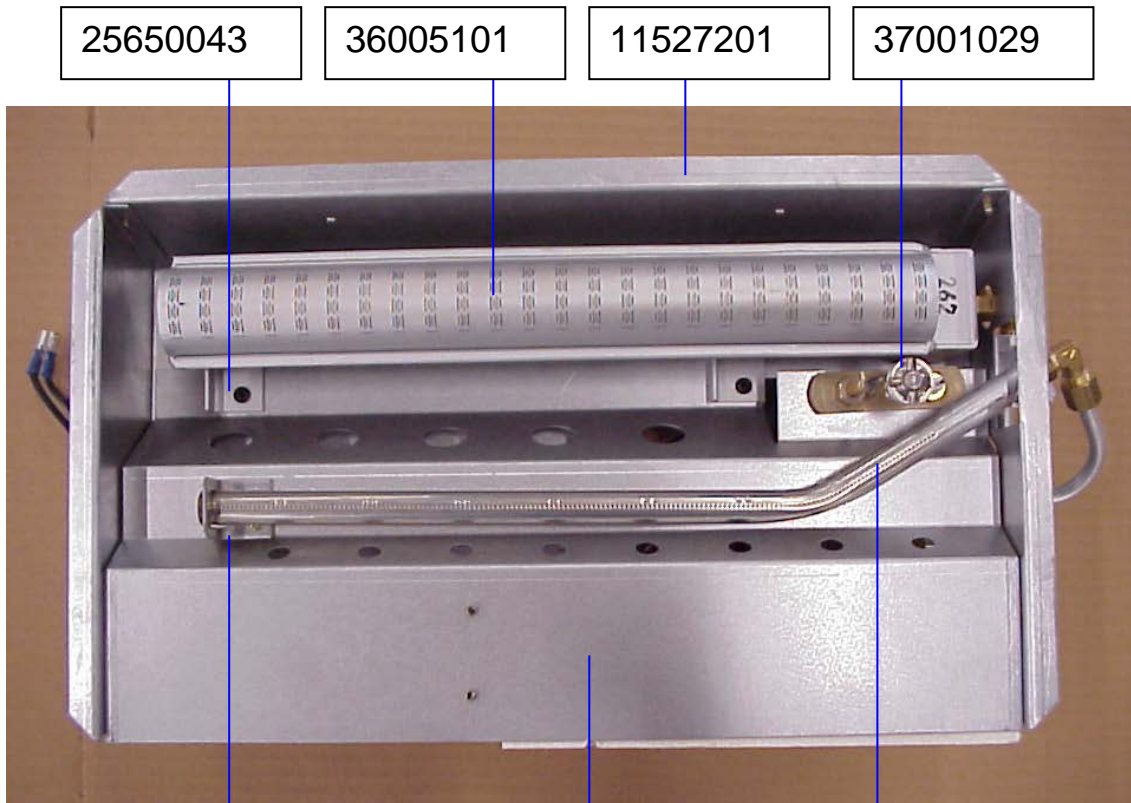
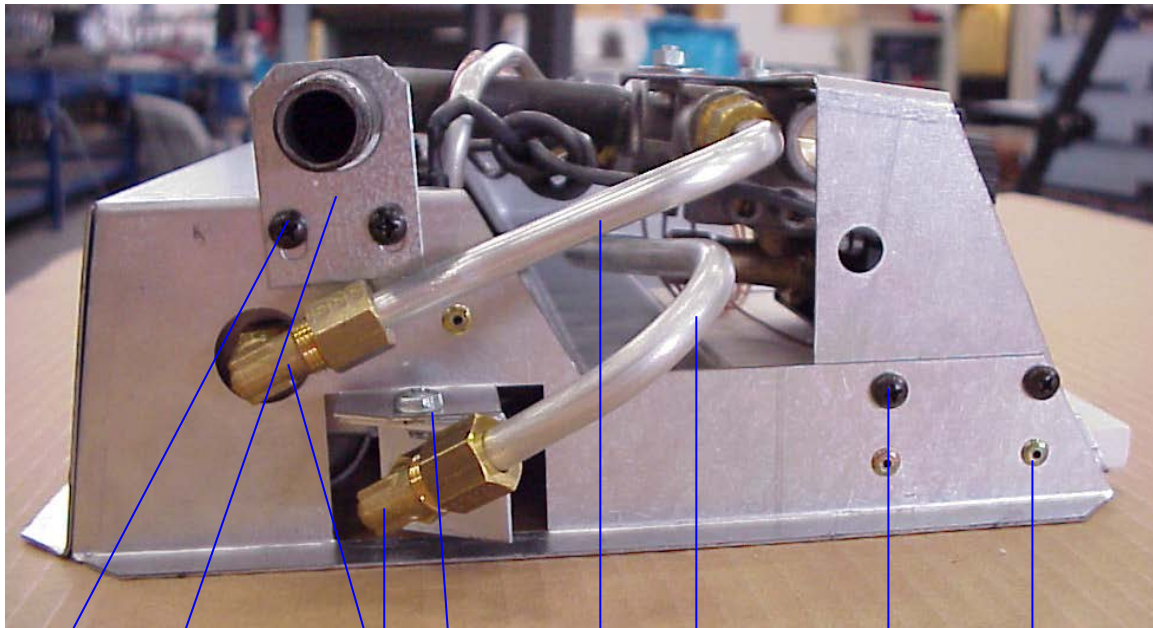

- 25650043
- 33000320
- 12080240
- 27540250
- 11529901
- 25015060
- 12080145
- 25650043

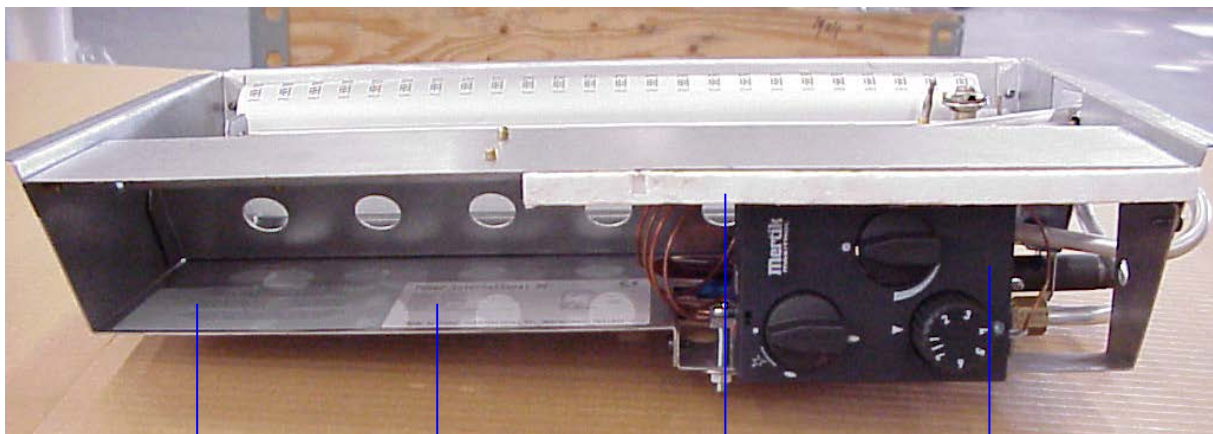

- 39001154
- 39001290
- 04016600
- 37007043

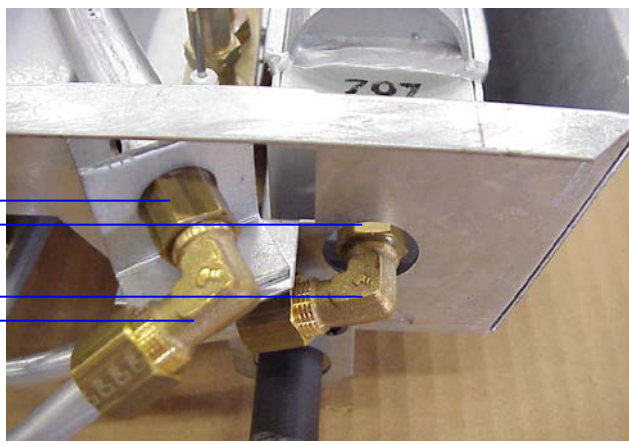

- 13381XXX
- 33000320
SEAL WITH
LOCTITE 570

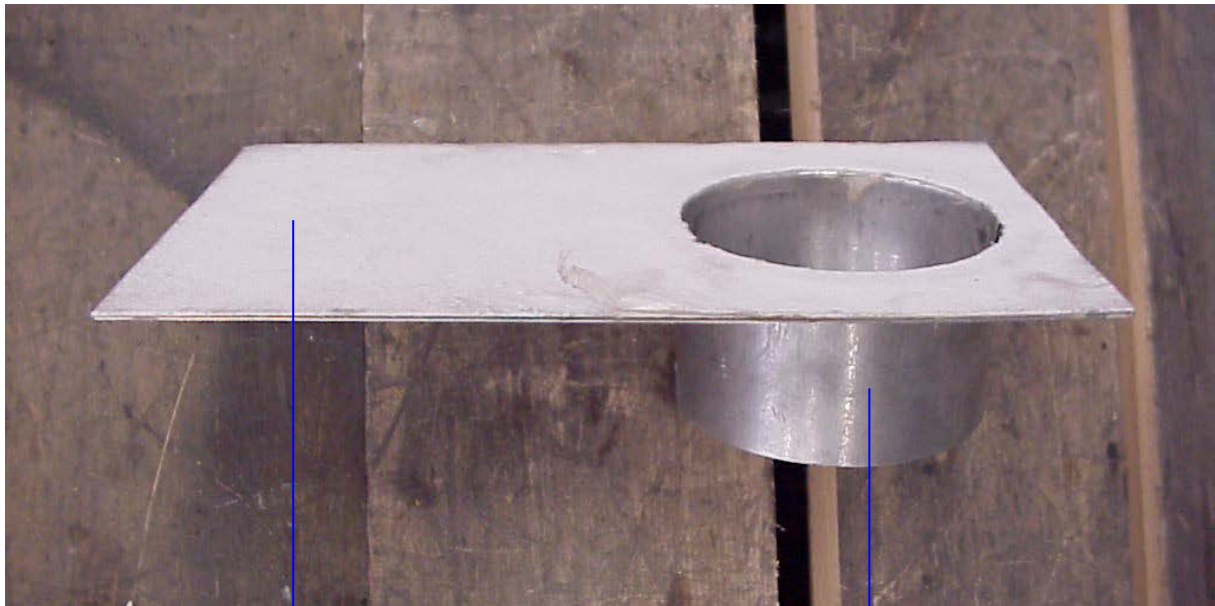

04016800
GLUE WITH
07900002
GLUECON 1000

20280400

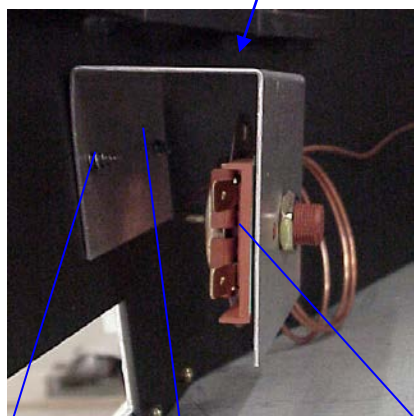
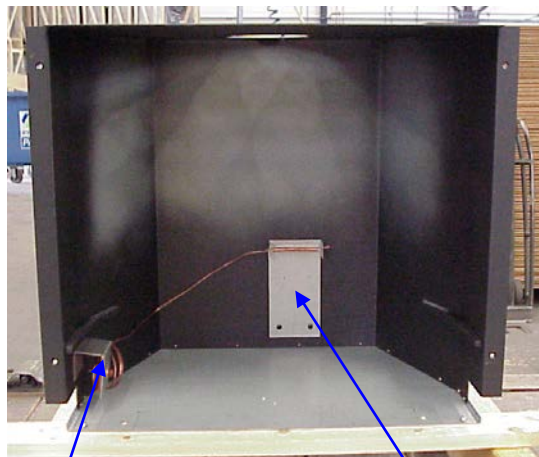

25650043

11529701

37006055

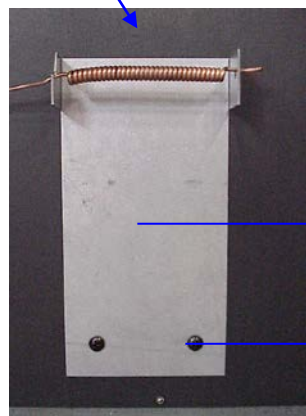

11169601

25650043

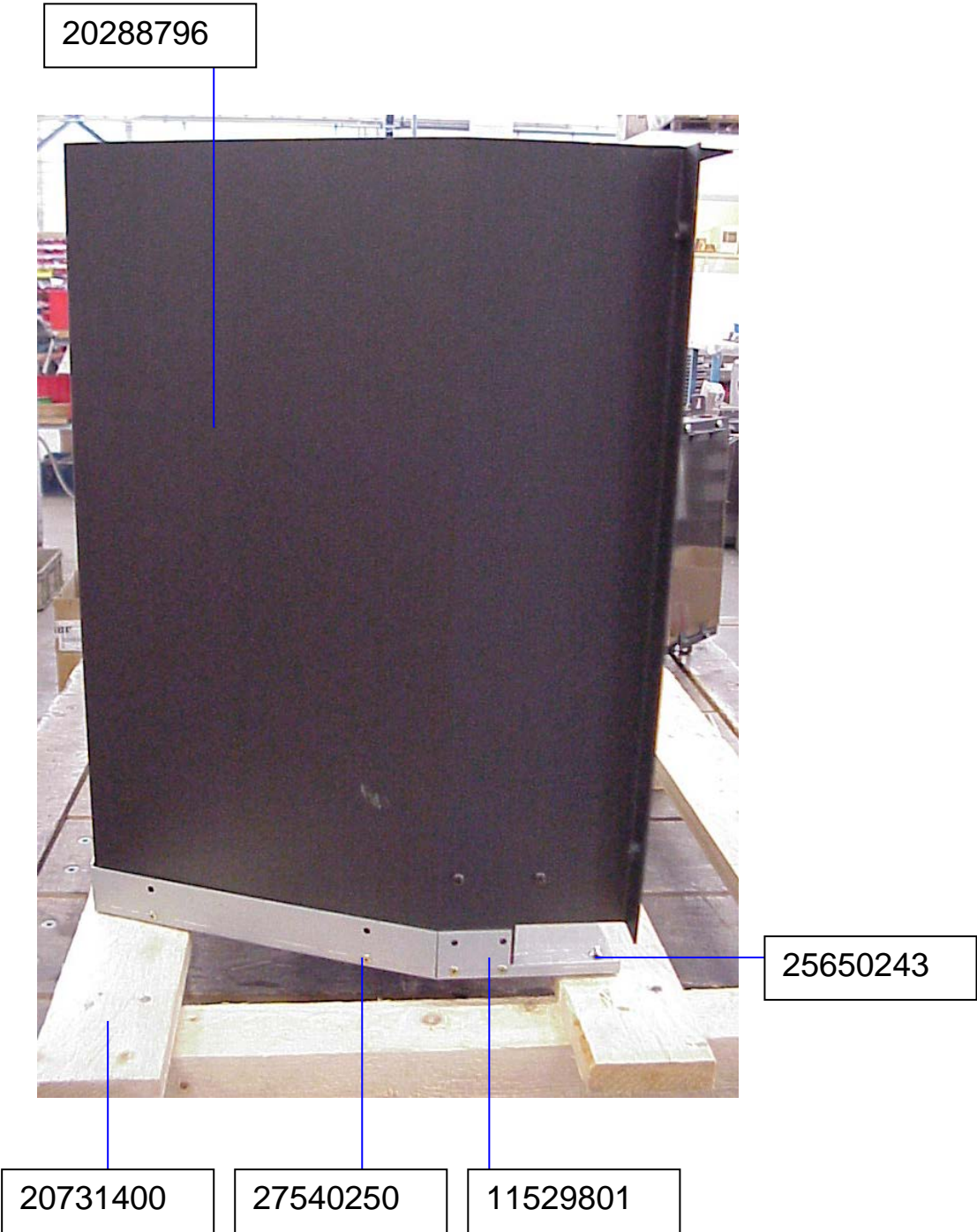

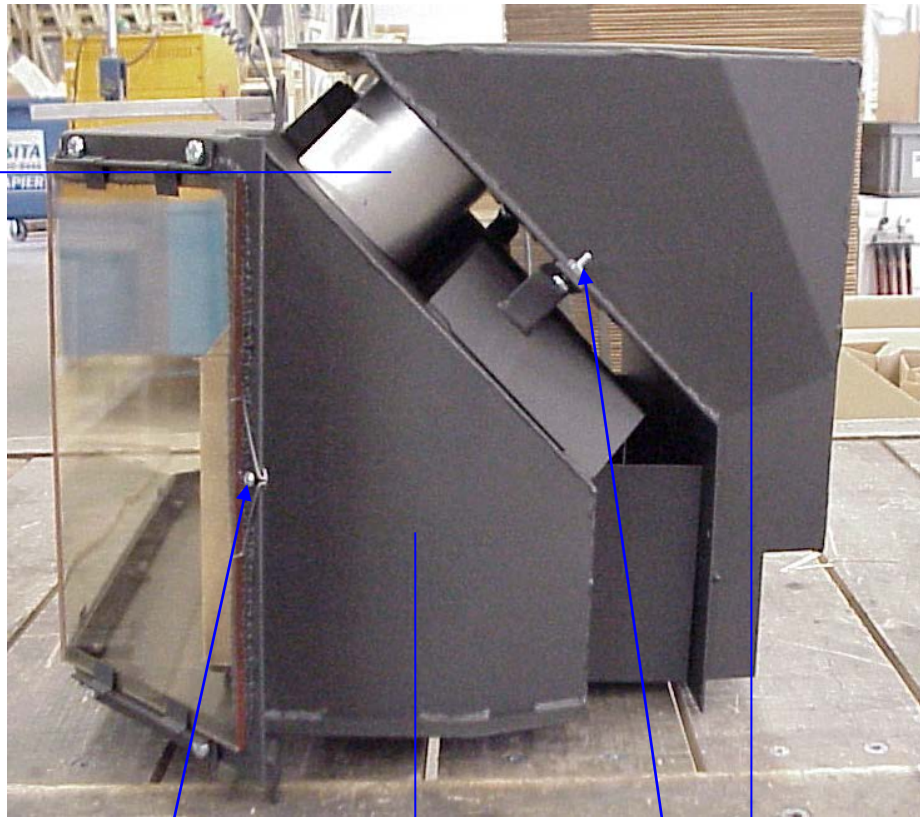

11208801

20288596

20288696

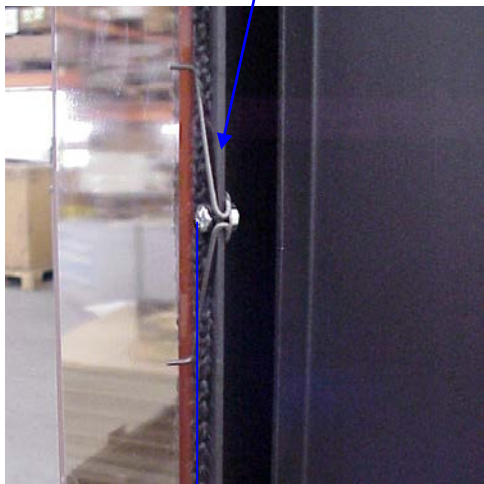

27130080
25014080
27000040
26020040

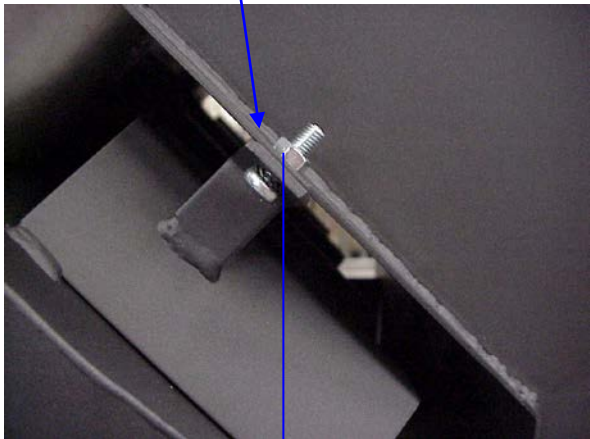

25016200
26020060

25016120

25156160

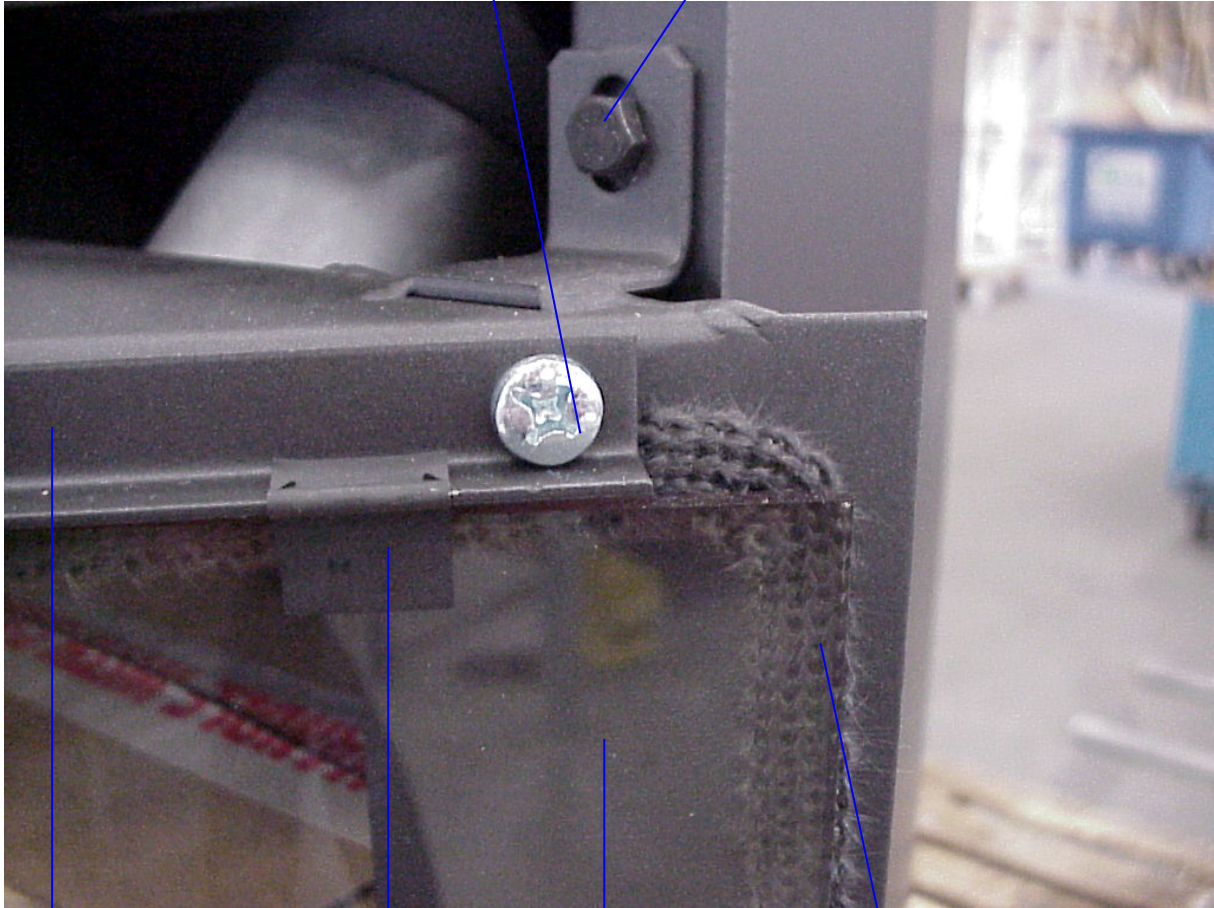

11106096

26230020

20731100

04002600

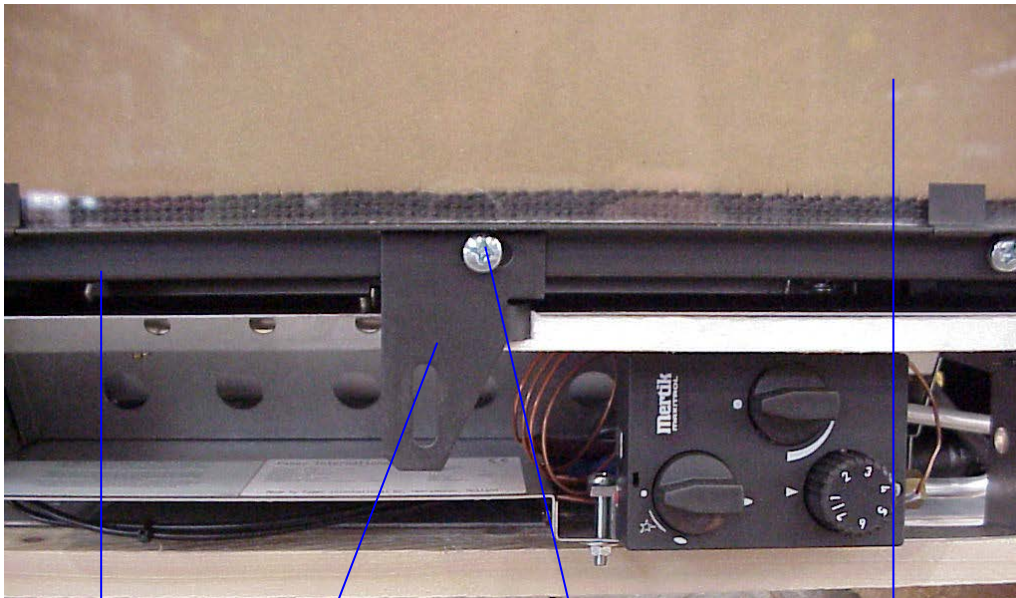

11105996

11127596

25016160

20731000

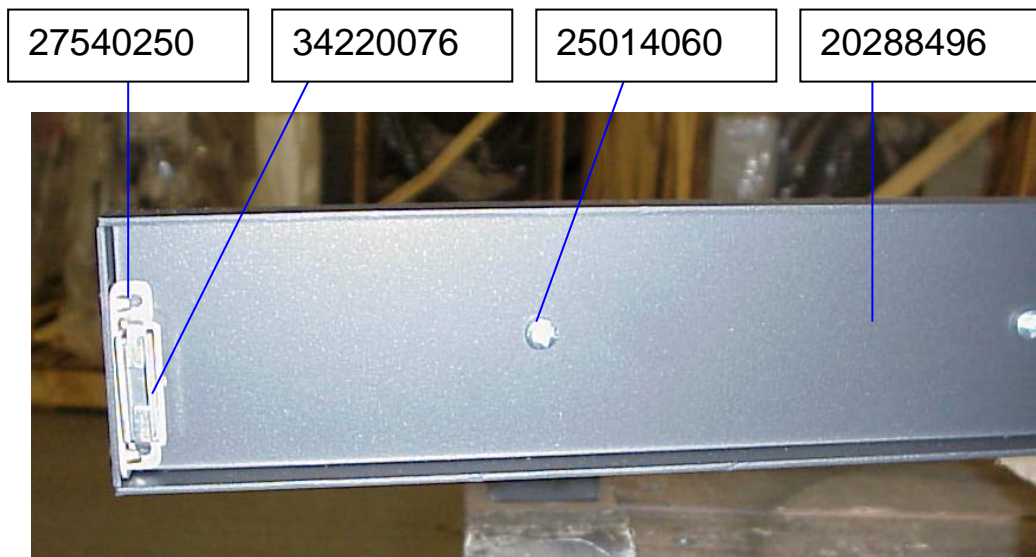
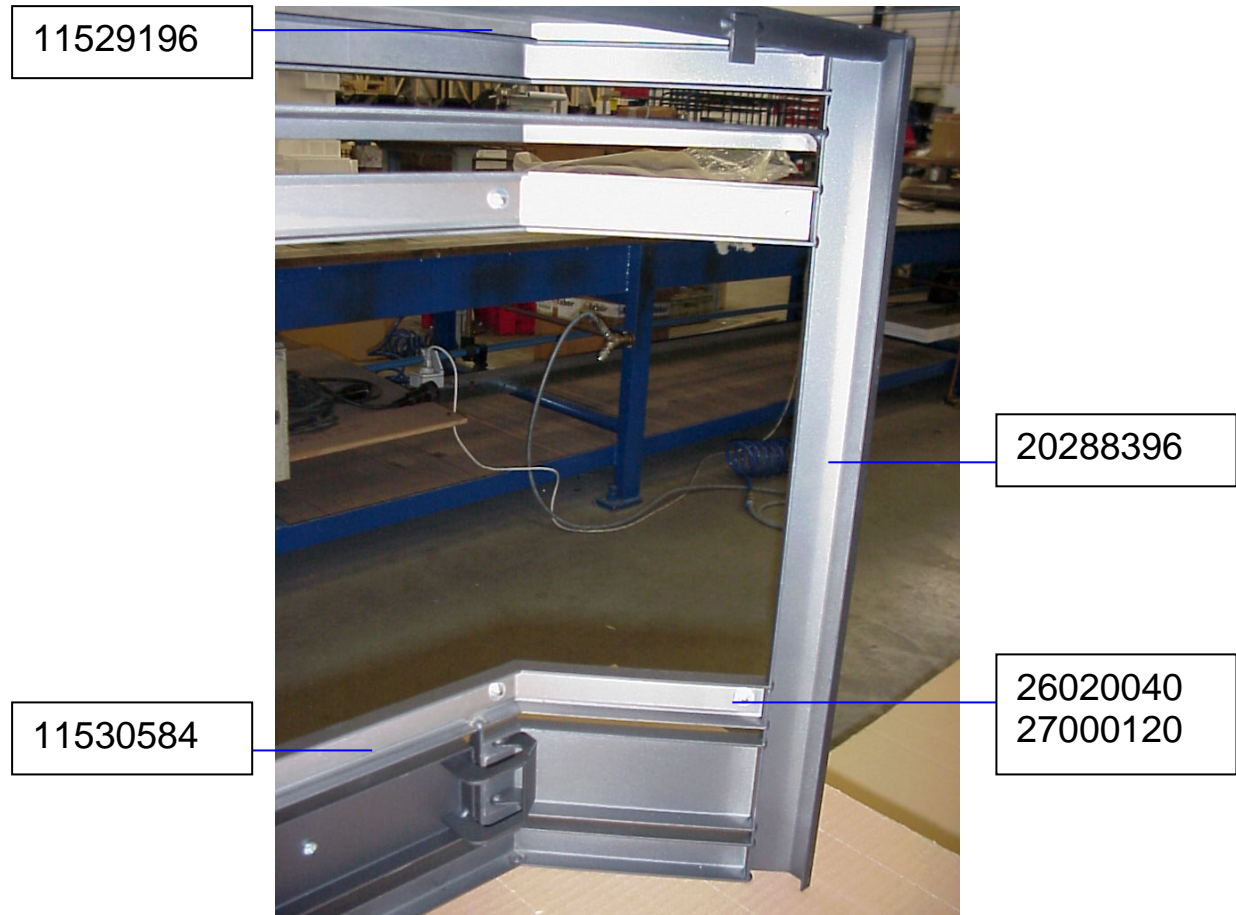



26020060
25016120
27050130

39001260
26200140

20288800

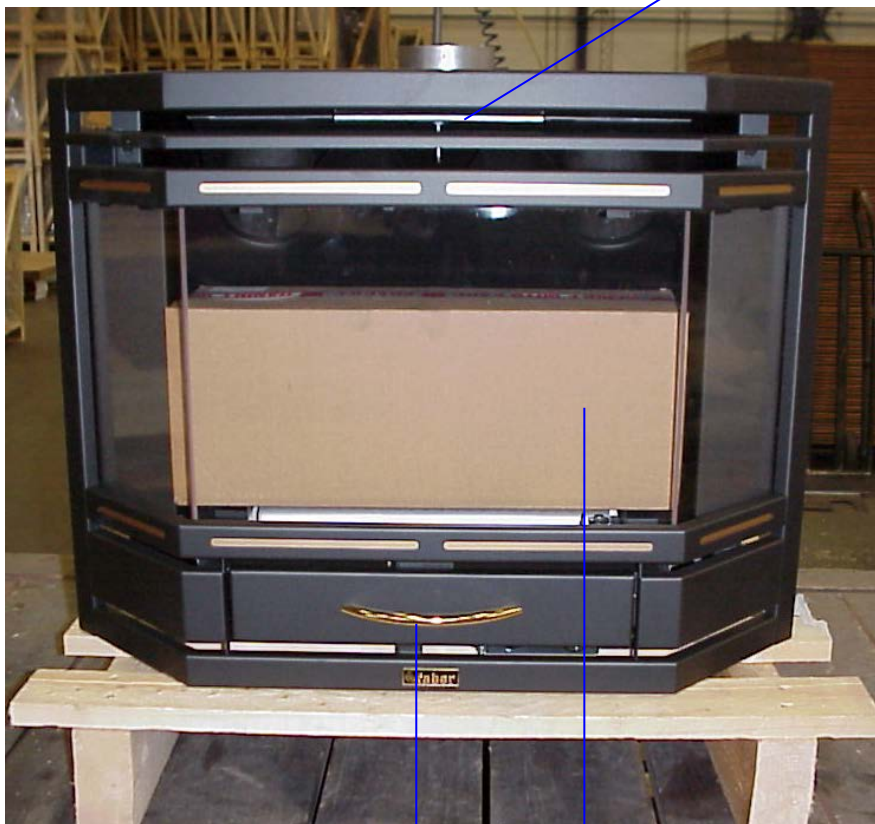

13404000

20754900

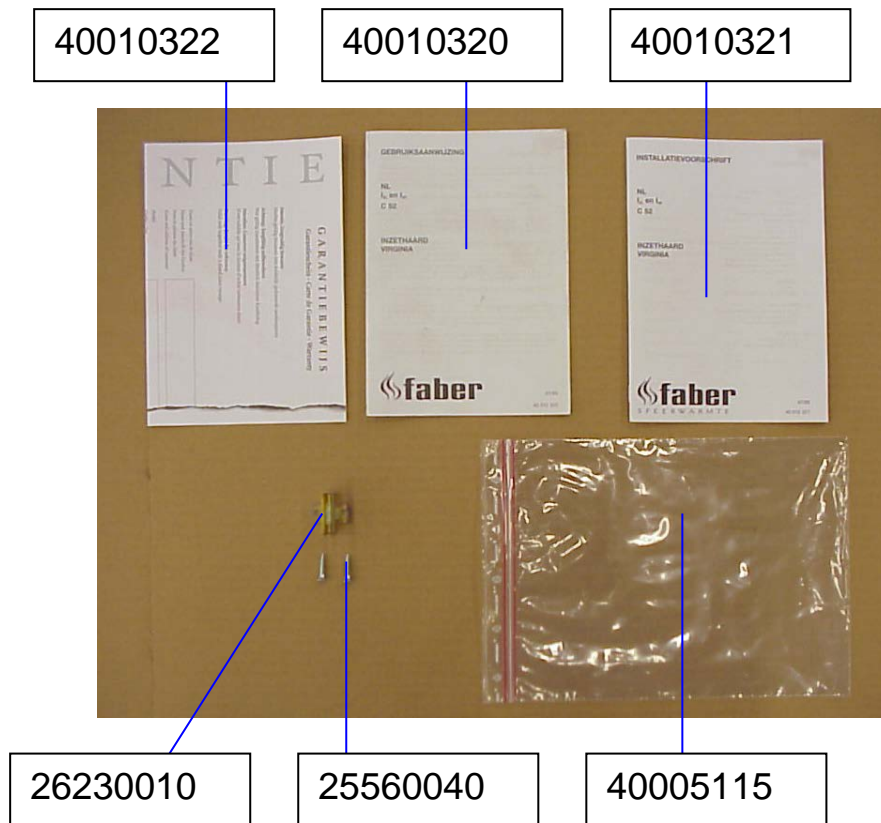

40001362

40001364



40001381

39006001

40005023



39001287

